

Opis znaczeń kolorów:

Linia czerwona - przerywana i ciągła: minimalny otwór w stropie, wymiary w mm.
 Linia czarna: długość i szerokość zabiegu schodów

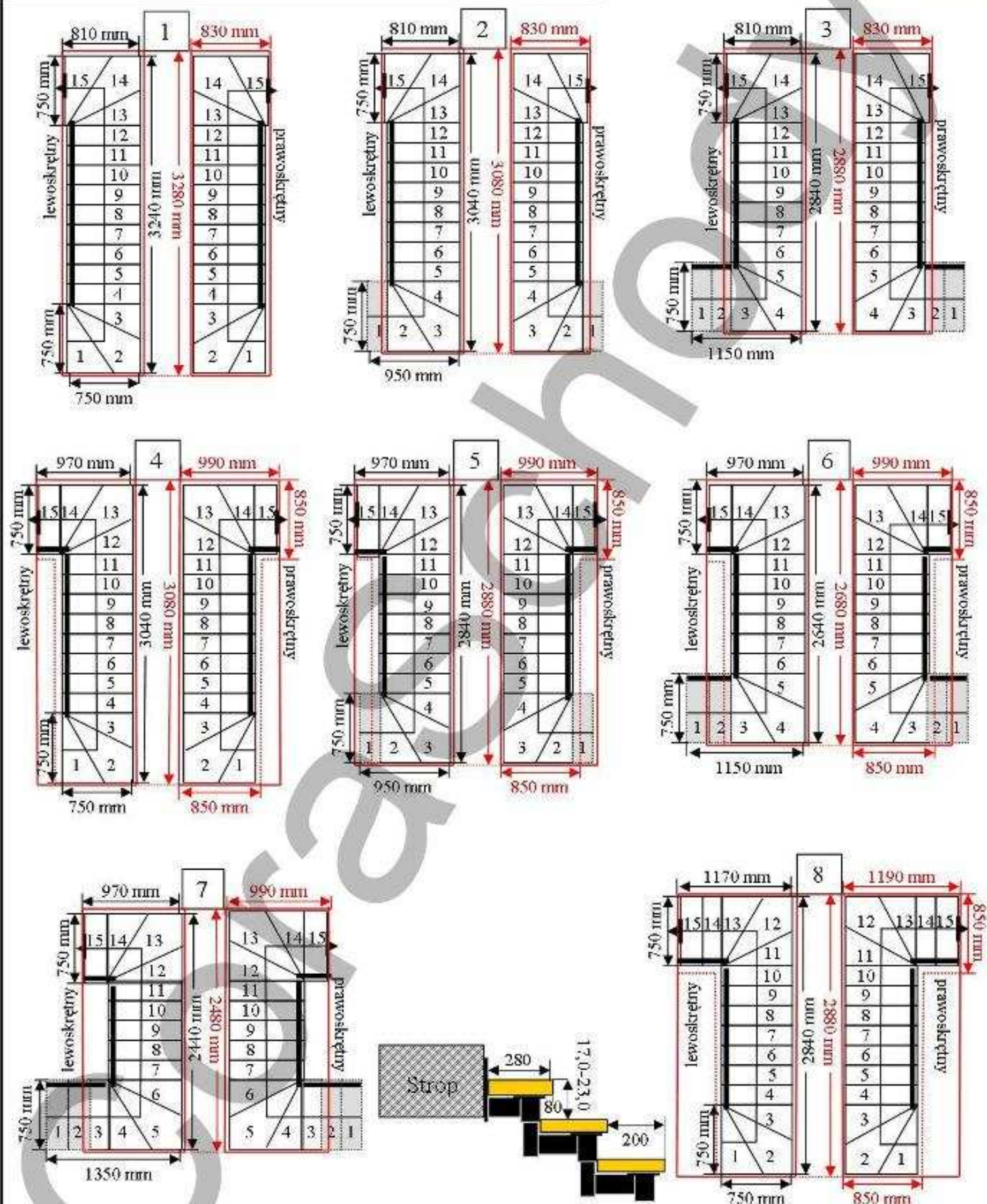

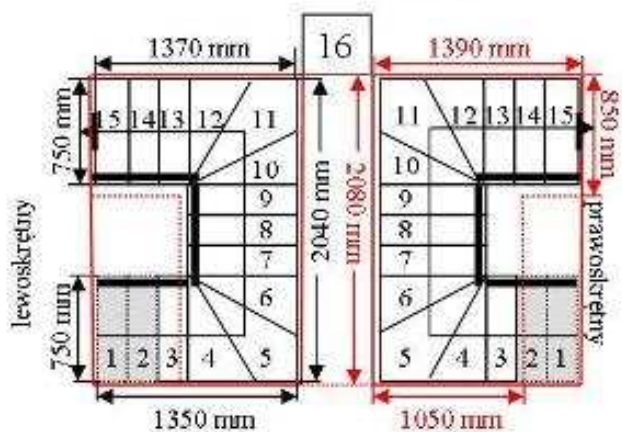

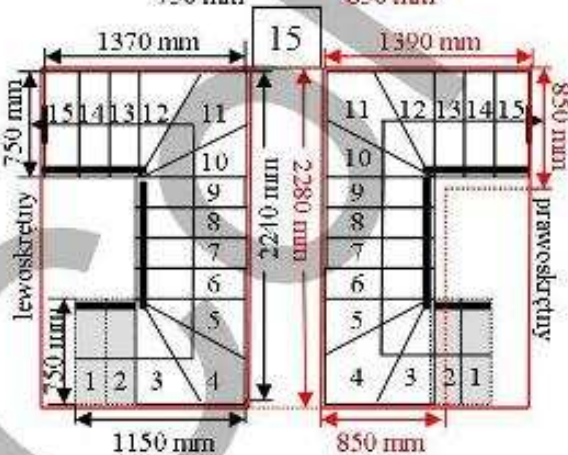
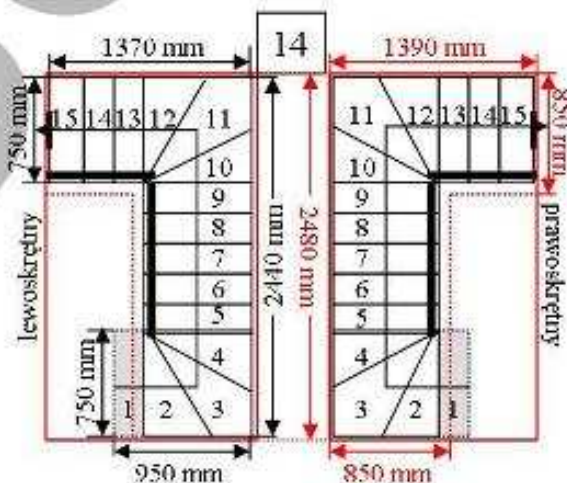
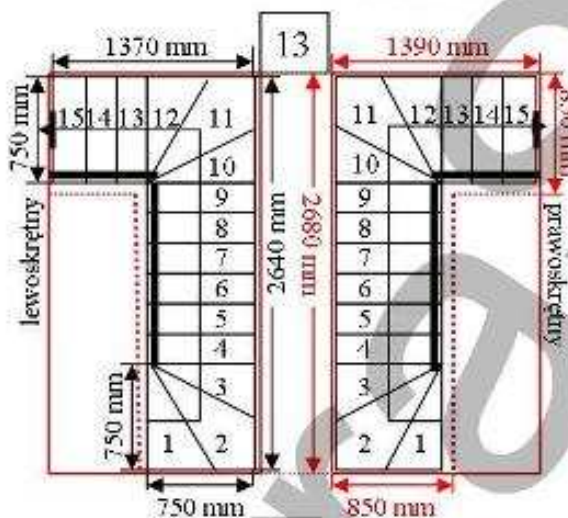
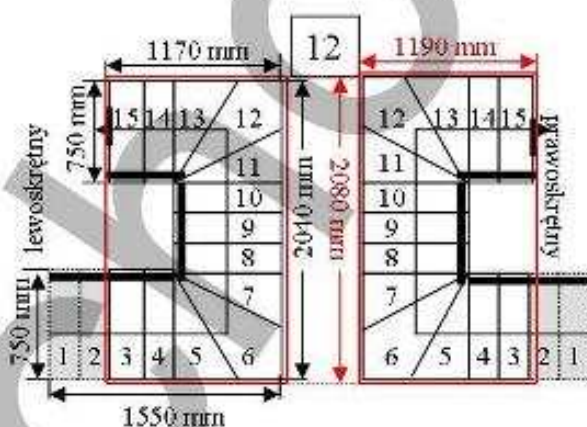
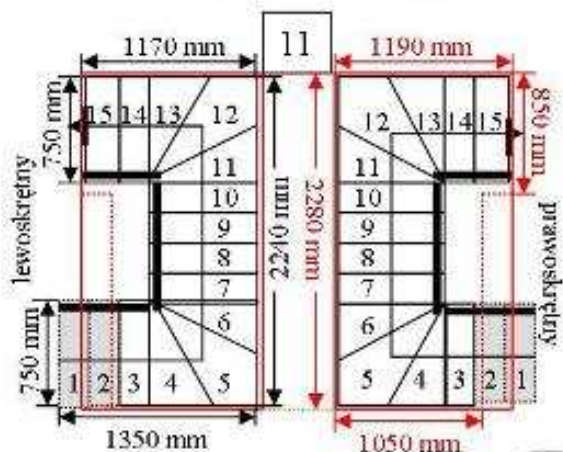
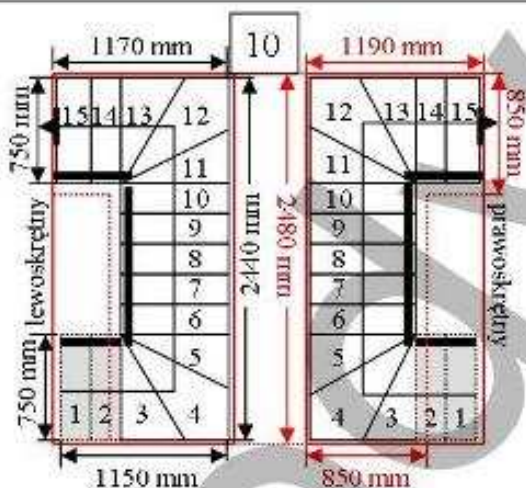
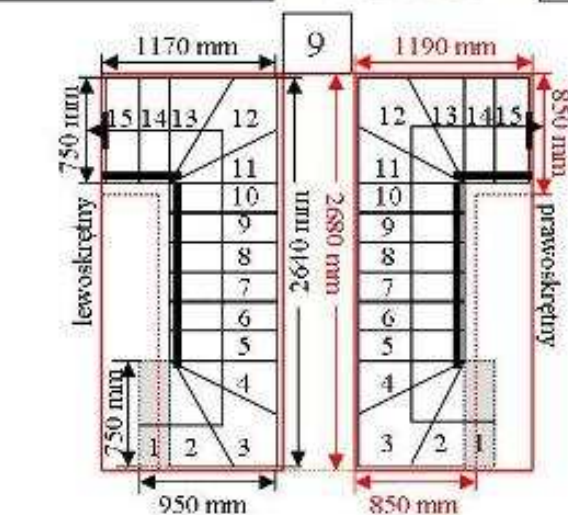
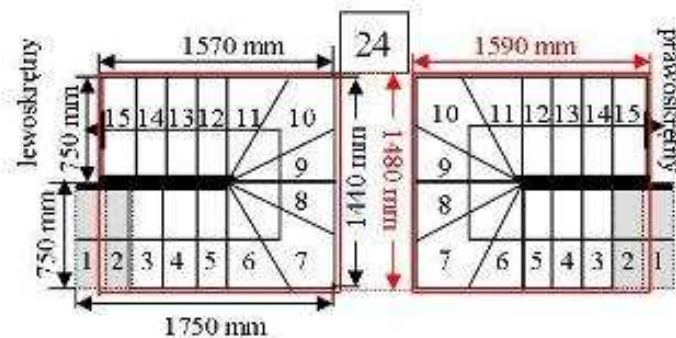
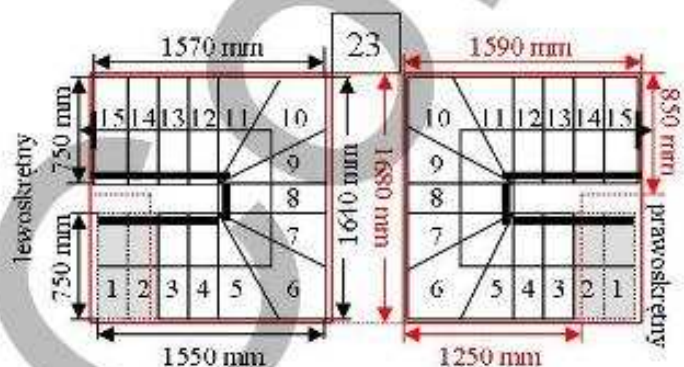
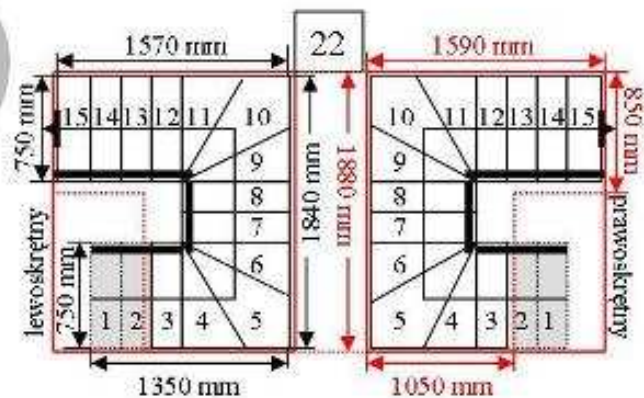
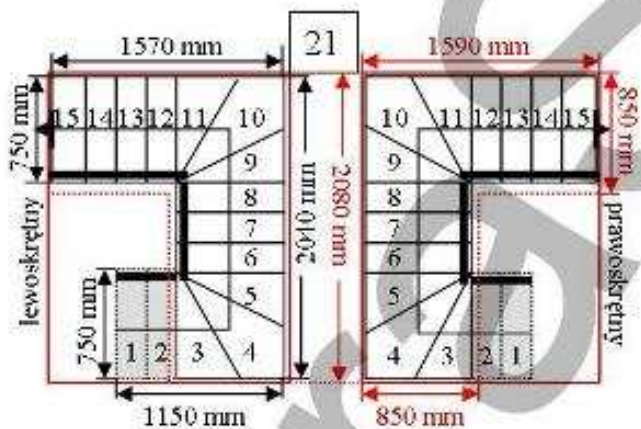
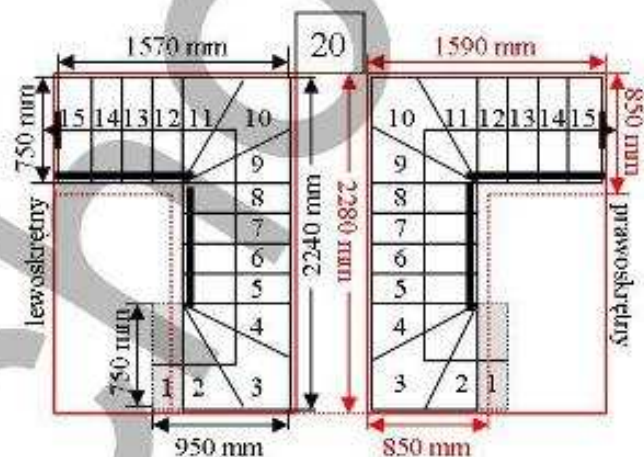
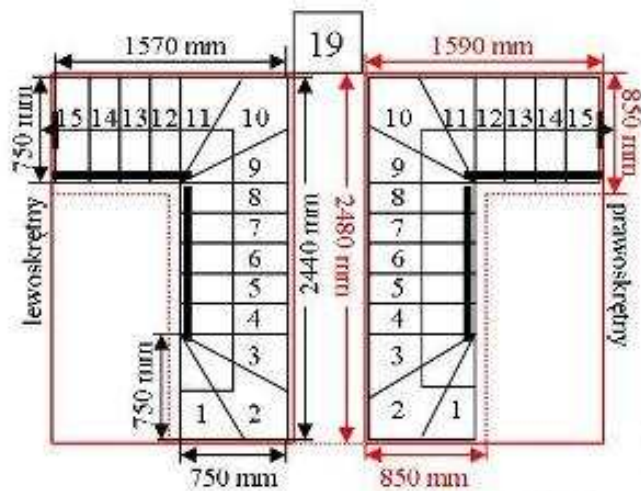
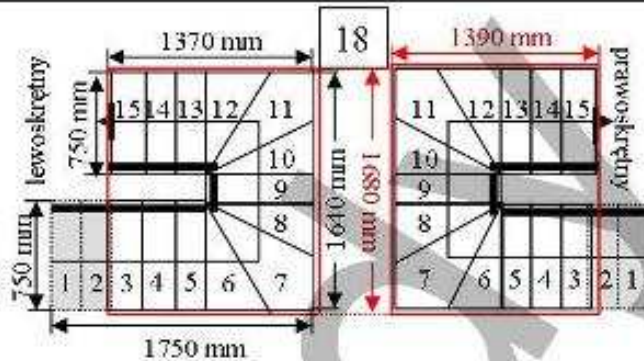
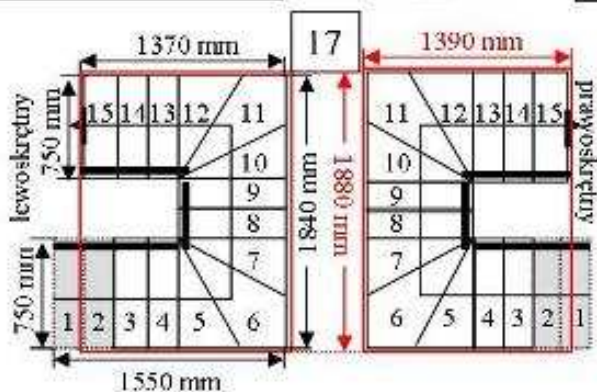

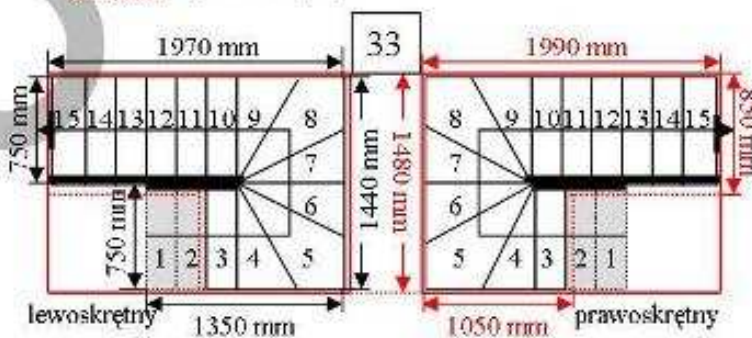
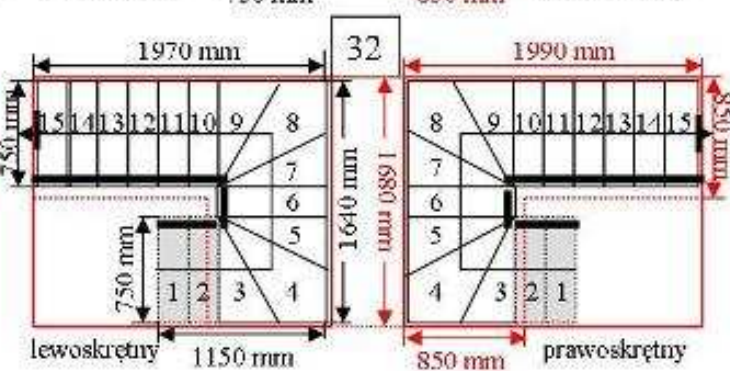
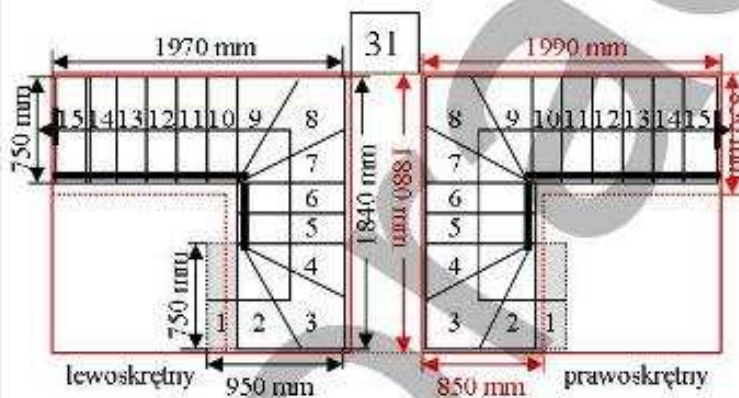
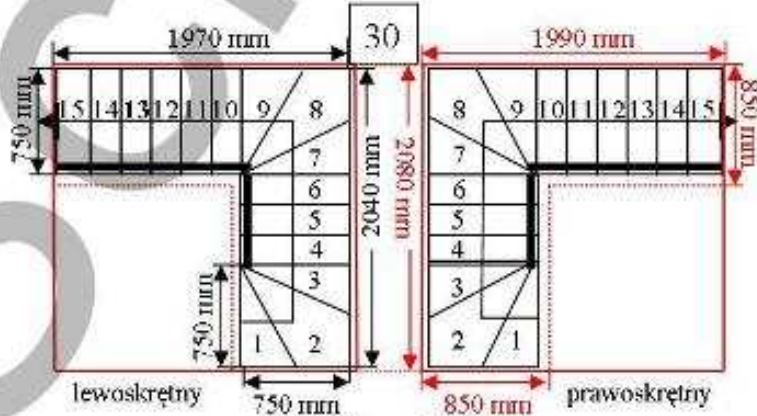
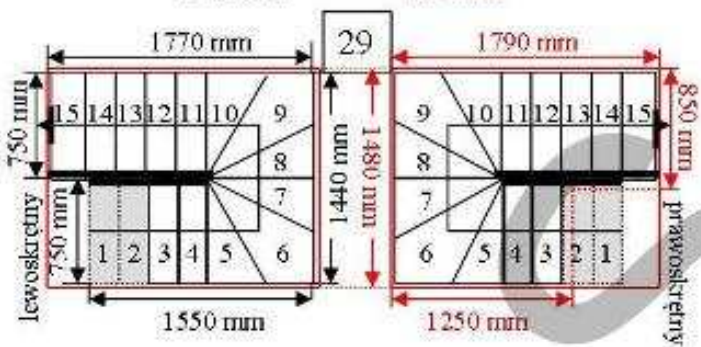
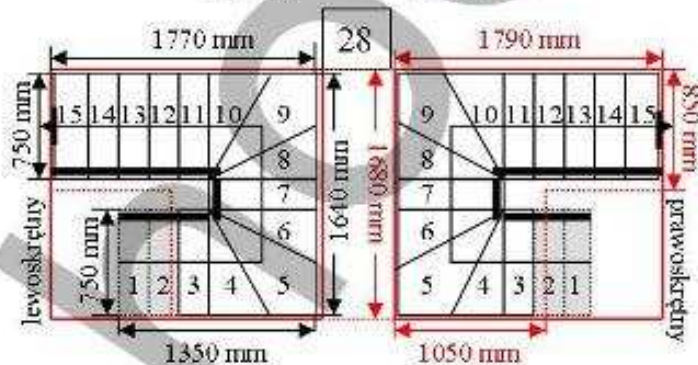
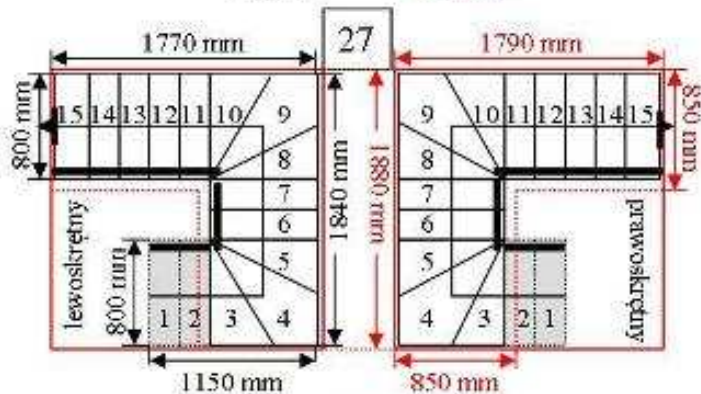
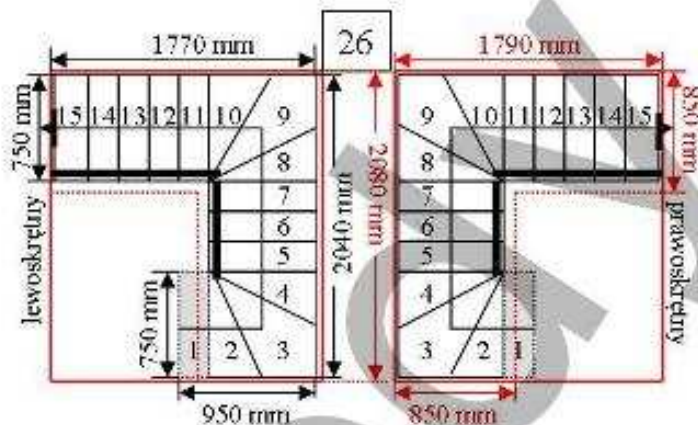
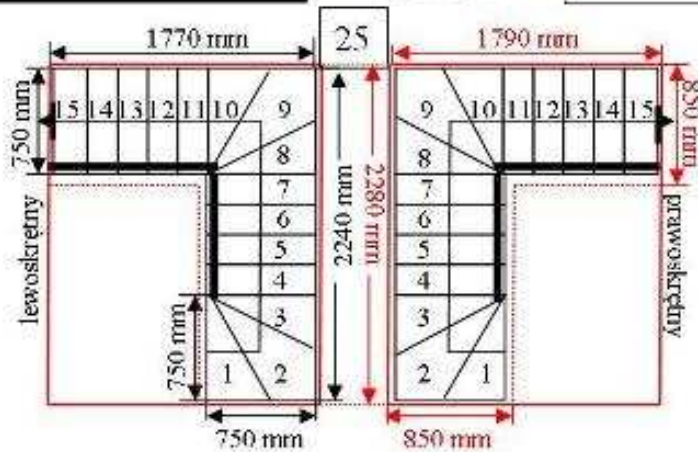



Opis znaczeń kolorów:
 Linia czerwona - ciągła i przerywana minimalny otwór w stropie, wymiary w mm.
 Linia czarna: długość i szerokość biegu schodów w mm.

