

Opis znaczeń kolorów:

Linia czerwona: przerywana i ciągła minimalny otwór w stropie, wymiary w mm.
Linia czarna: długość i szerokość zabiegu schodów

CORASCHODY

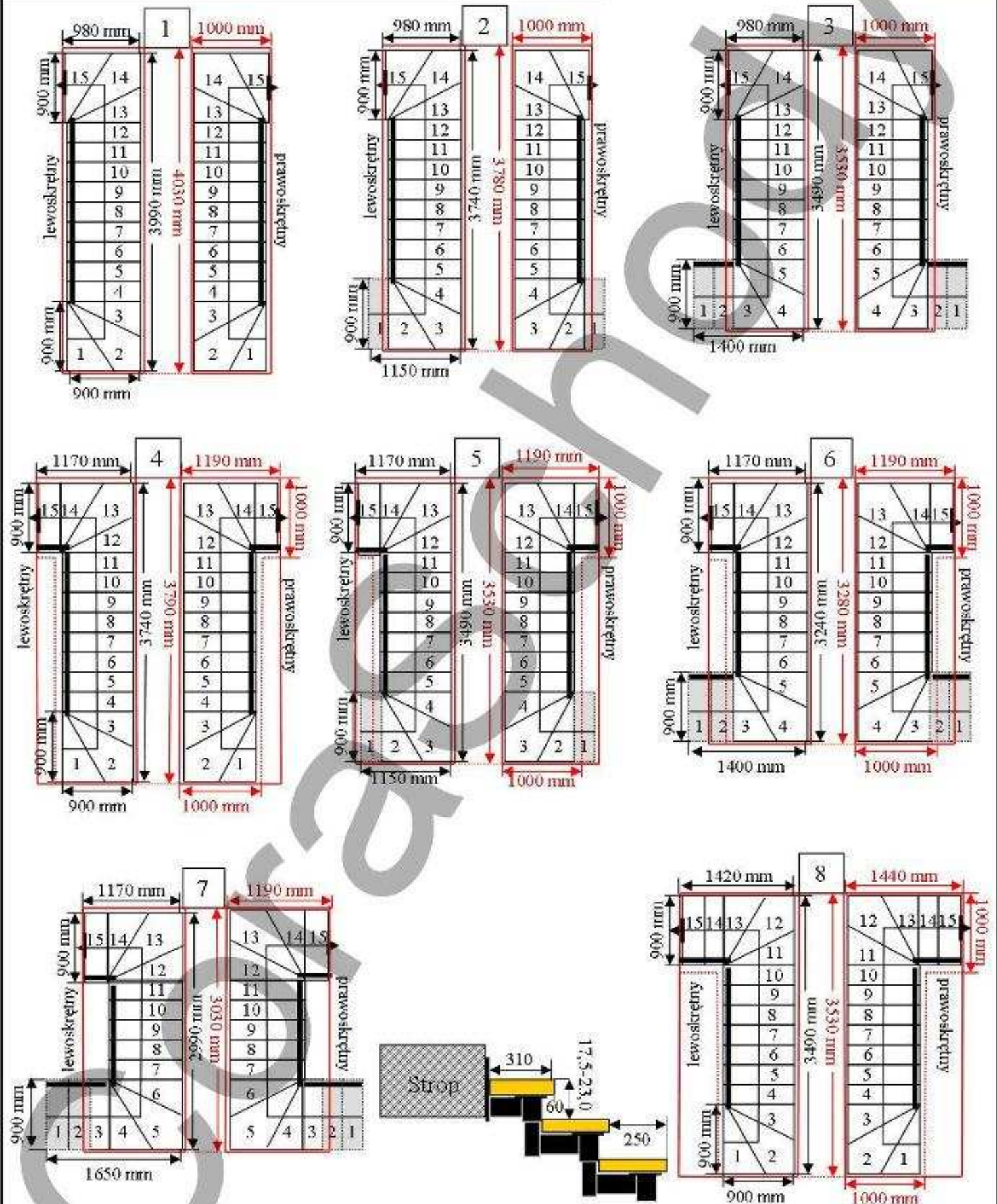

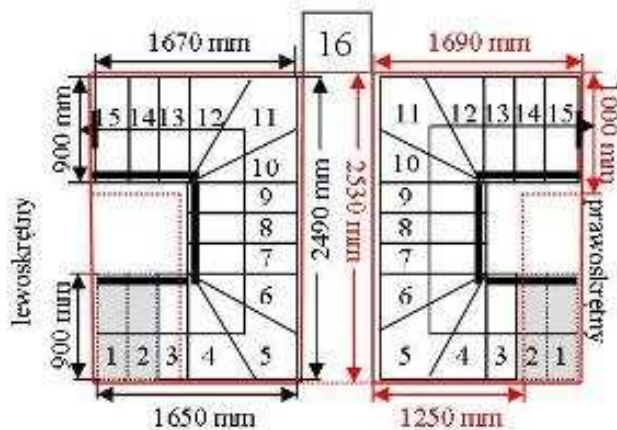
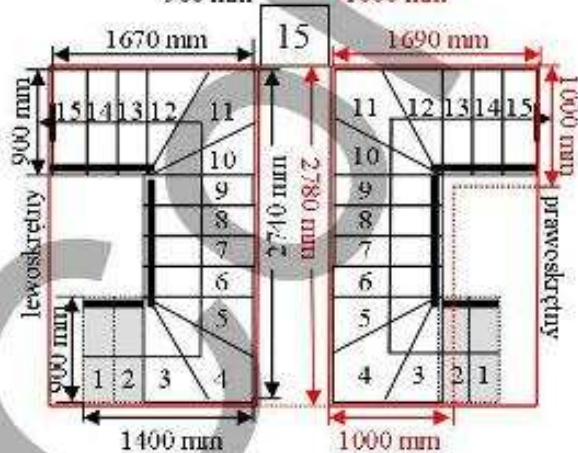
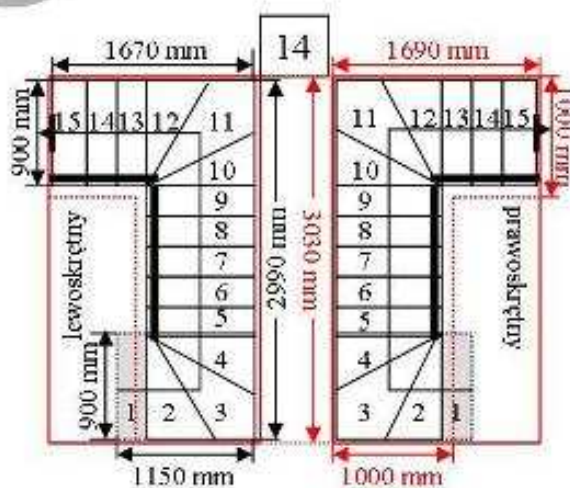
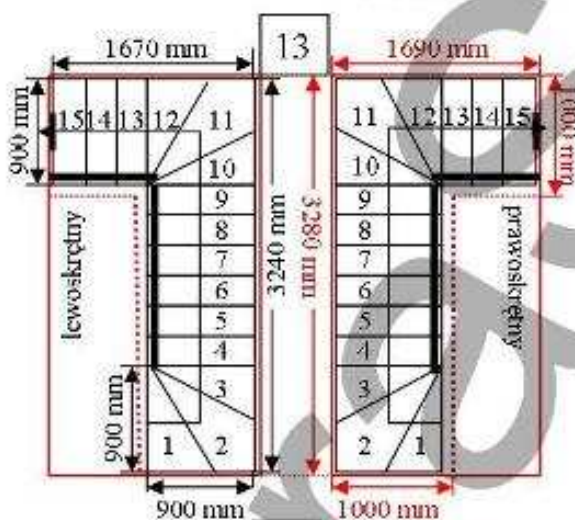
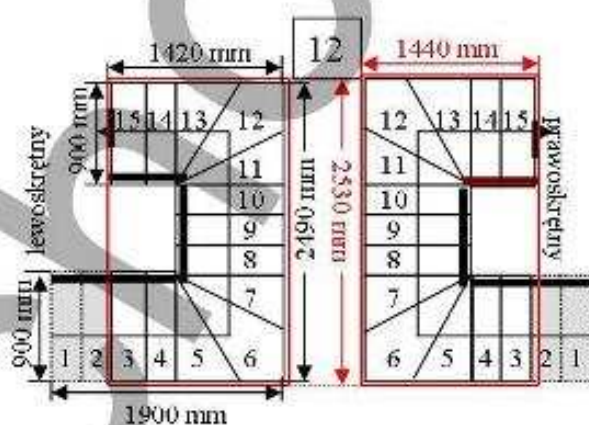
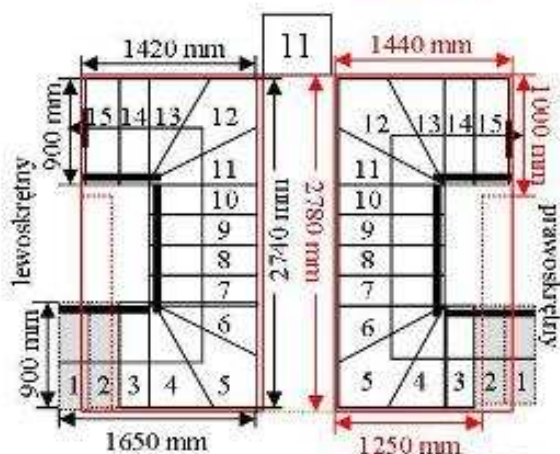
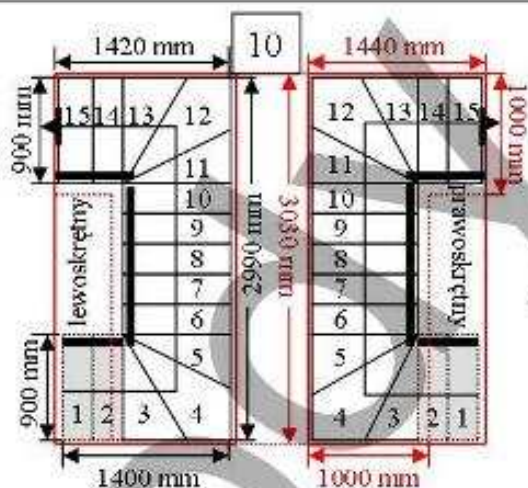
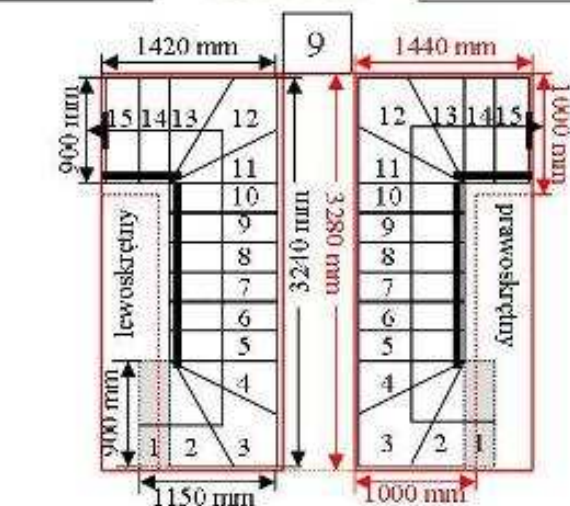

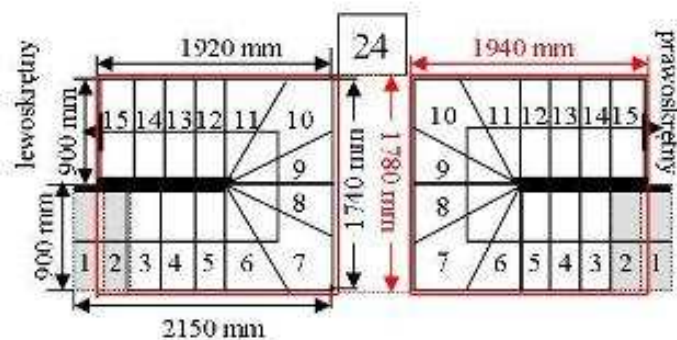
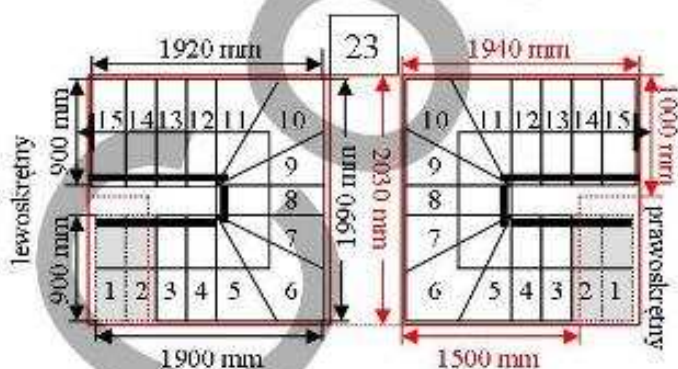
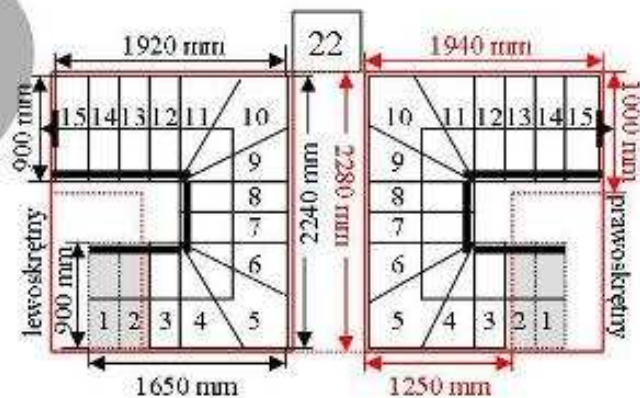
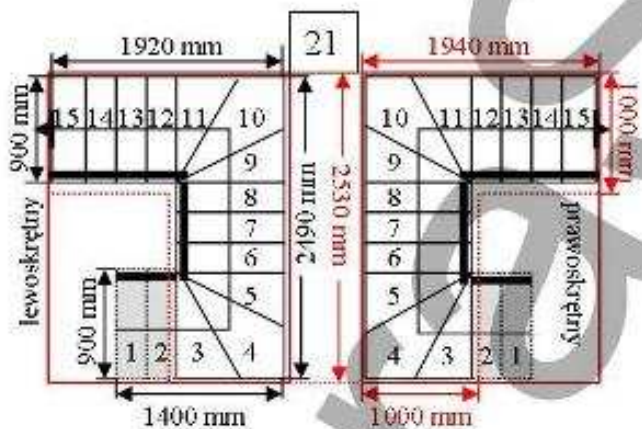
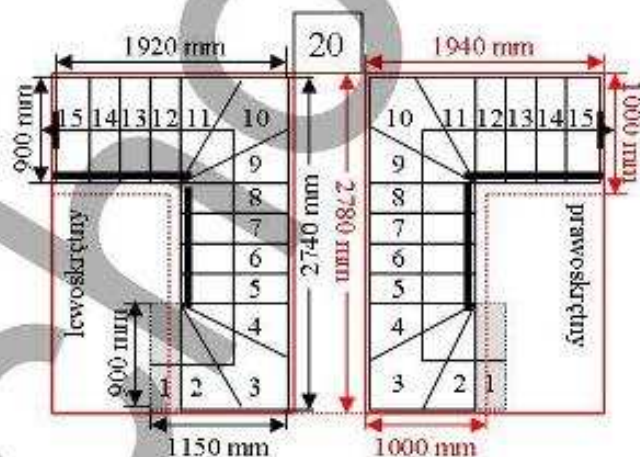
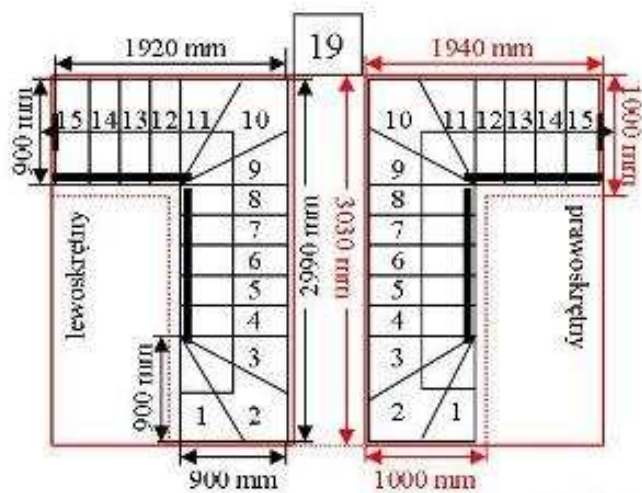
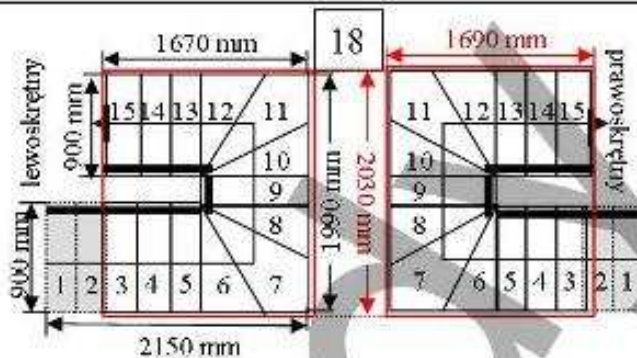
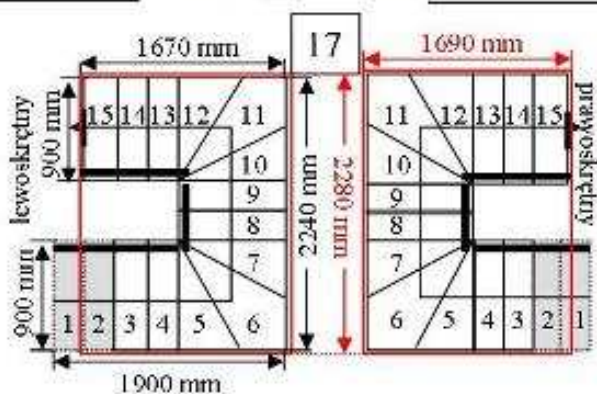

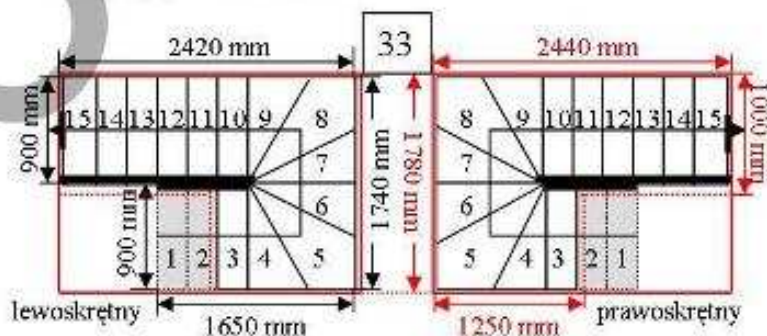
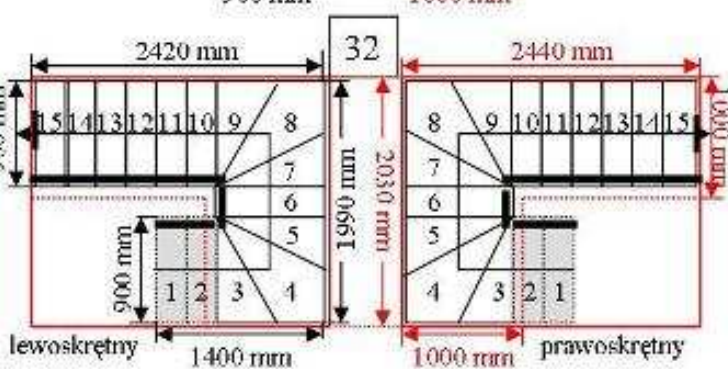
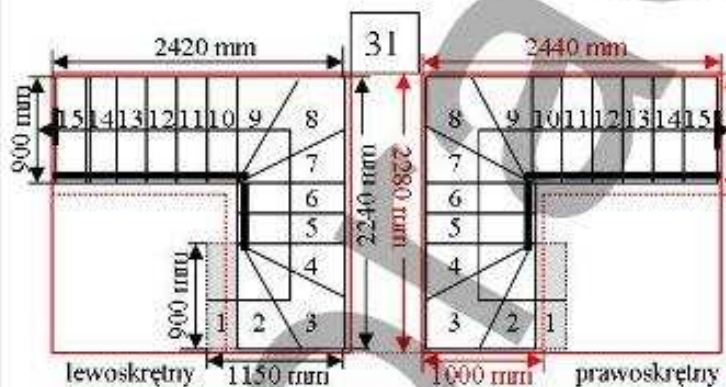
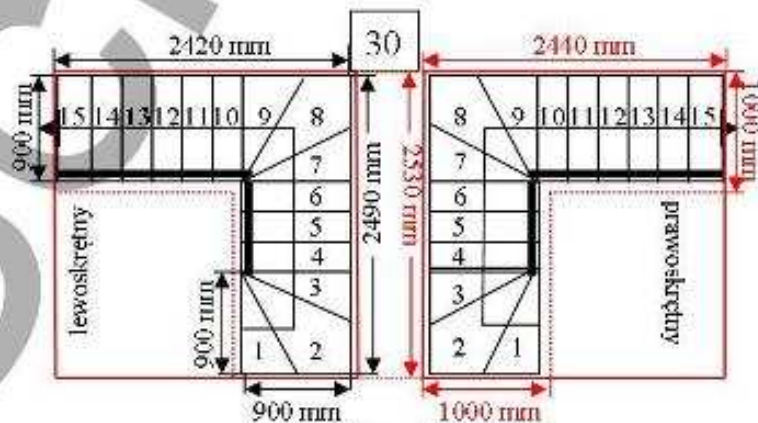
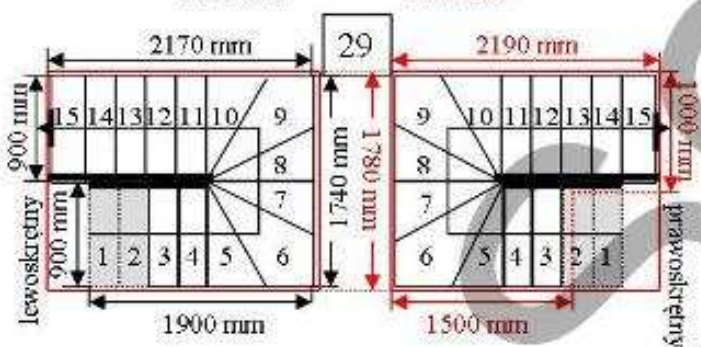
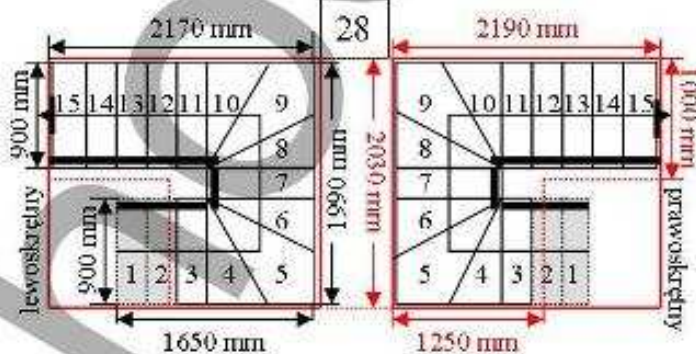
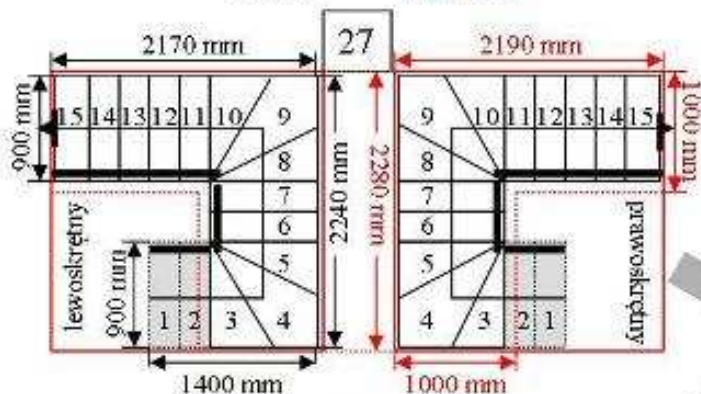
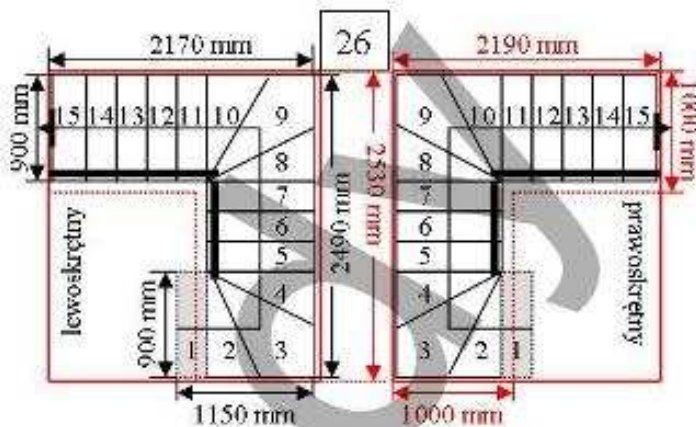
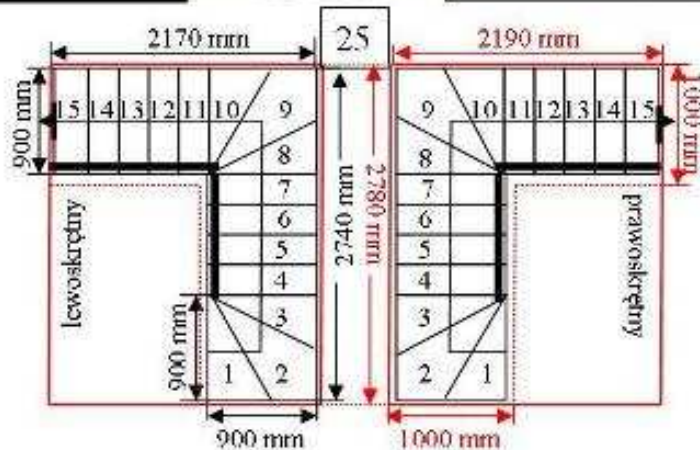



Opis znaczeń kolorów:
Linia czerwona - ciągła i przerywana minimalny otwór w stropie, wymiary w mm.
Linia czarna - długość i szerokość biegu schodów w mm.

